

S2 COMPARATOR STAND

The S2 precision comparator stand was designed for manufacturing areas requiring high accuracy such as grinding and inspection departments. It is recommended for use with all Dorsey high amplification dial and digital indicators, but will accommodate other gaging devices having a standard .375" or 8mm diameter mounting stem.

The S2N production and shop area comparator stand is specifically designed without fine adjustment for use with digital indicators, long range indicators, and electronic probes with remote readouts. The S2N stand maximum gaging height is 4.0" inches and the throat clearance is 2.4".

FEATURES:

- ✔ Unique fine adjustment head - Dorsey's frictionless reed spring design prevents backlash and drifting. Ensures rapid, precise zero positioning of any dial indicator. Permits Dorsey high amplification dial indicators or other gaging instruments of equal sensitivity to perform to their full capability of measuring to millionths of an inch repetitively and accurately.
- ✔ Ground stainless steel columns provide maximum wear and corrosion resistance.
- ✔ Precision machined and ground cast base ensures perpendicularity of column to anvil.
- ✔ Anvils for the S2 and S2N are made from hardened and lapped high grade tool steel.

Part# 47141
Straight serrated surface anvil 2" dia.

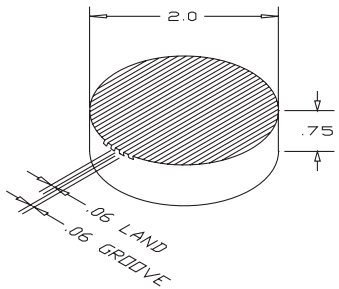

Part# 47113
Flat surface anvil 2" dia.

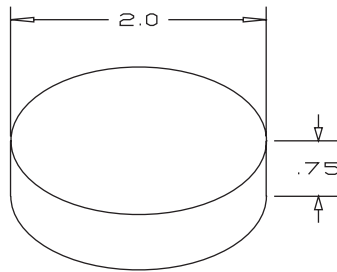

Part# 47139
Flat diamond serrated surface anvil 2"x3"

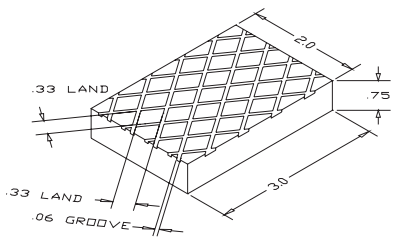

Part# 47138
Flat surface anvil 2"x3"

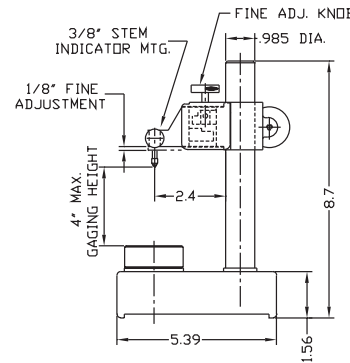
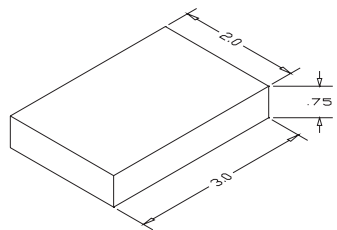

S2 comparator stand shown with optional #414-002 dial indicator

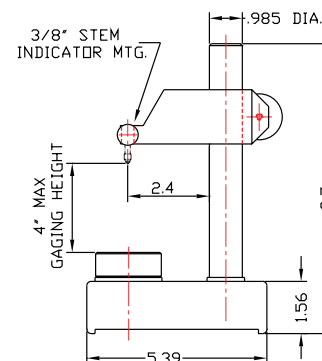
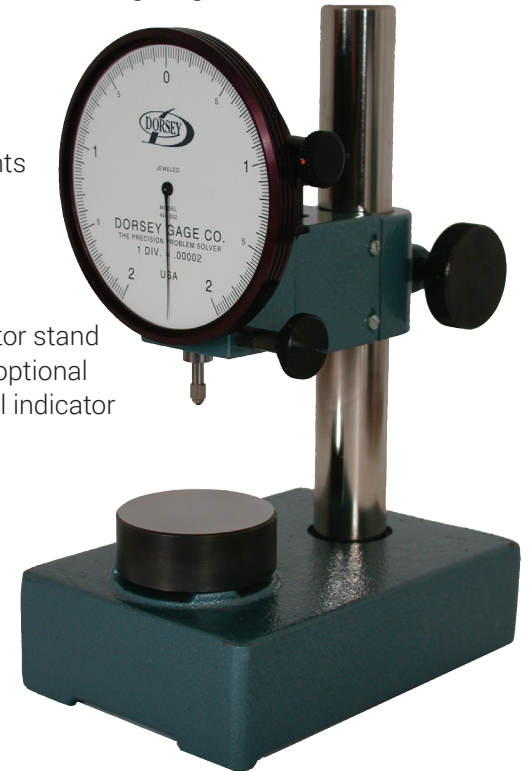

S2N comparator stand shown with optional extended range digital indicator

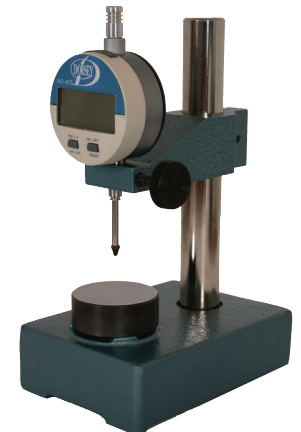

PART #	DESCRIPTION
47145	S2 STAND WITHOUT ANVIL
S2-HEAD	FINE ADJUSTMENT HEAD ONLY
47145N	S2N STAND WITHOUT ANVIL
For Anvil options, please see above	